

Profil gwintu

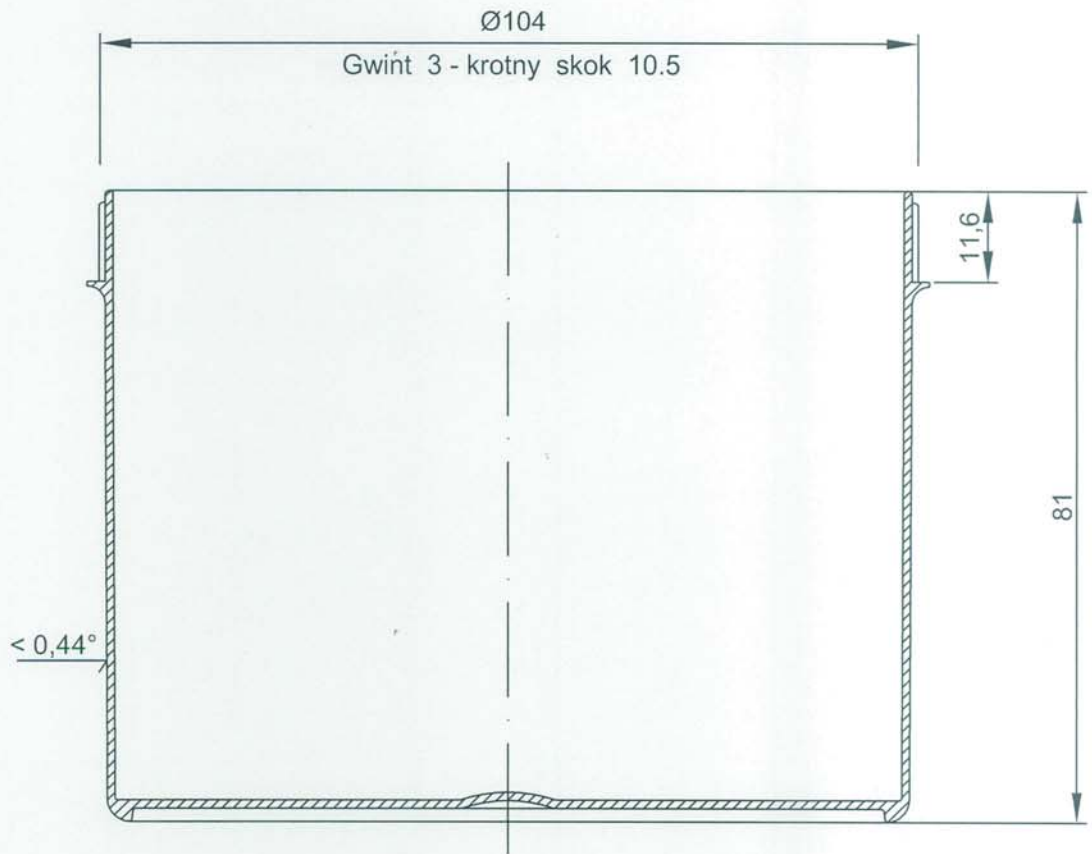

Szczegół obrzeża

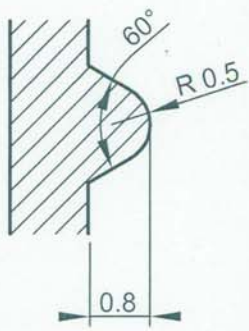
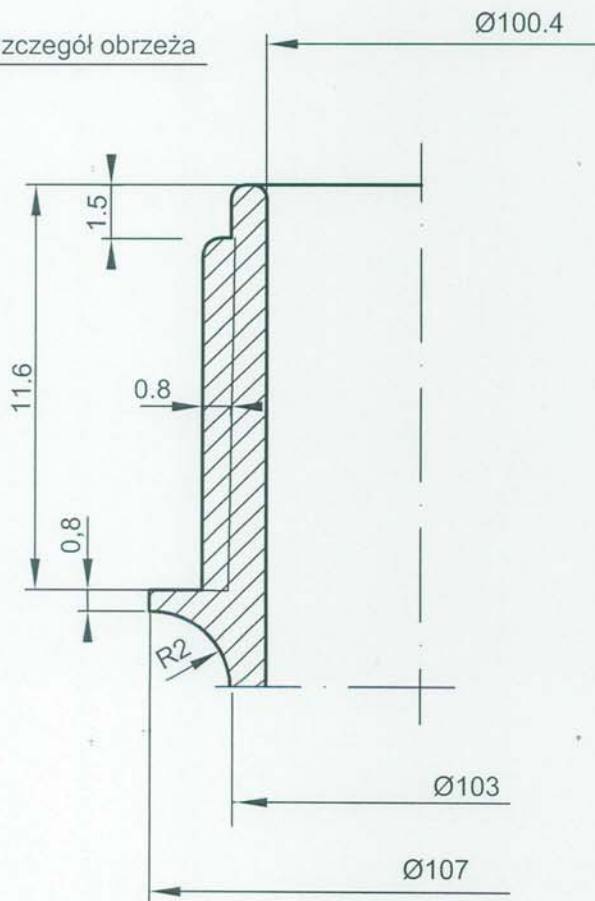

Szczegół dna

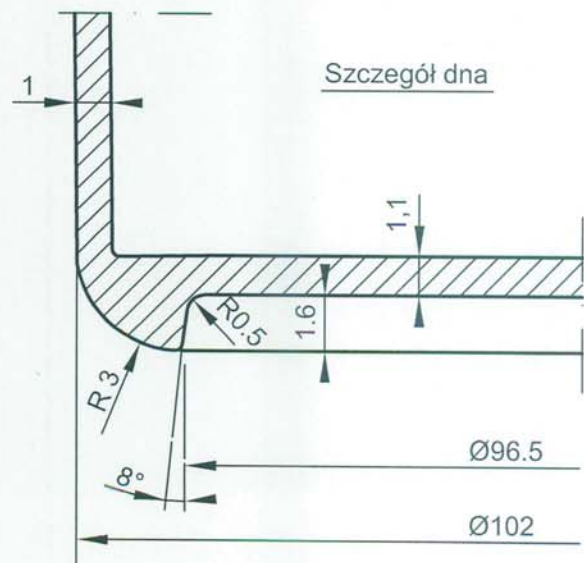

Dose H 81
DOS 600...PIP