

Profil gwintu

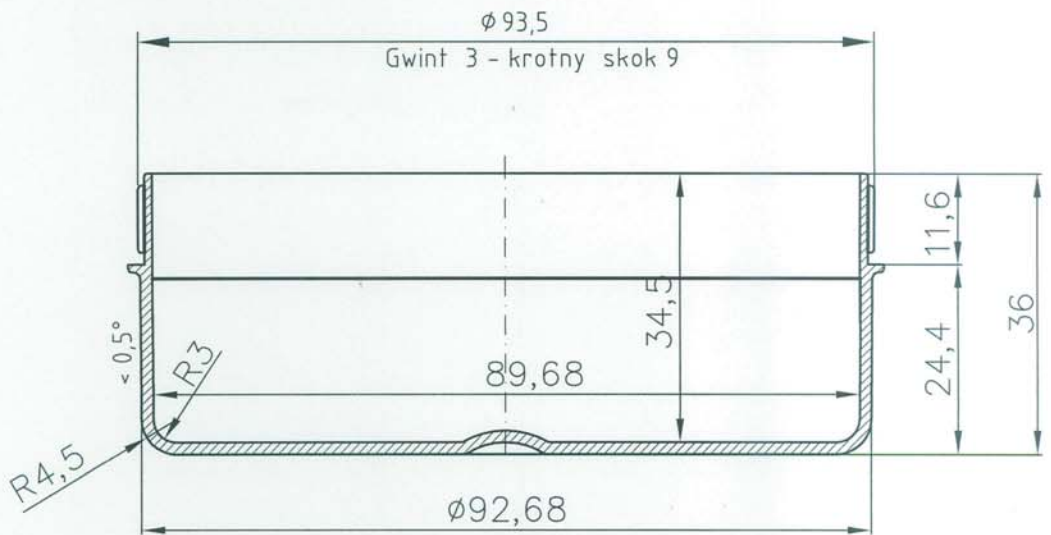

Szczegół obrzeża

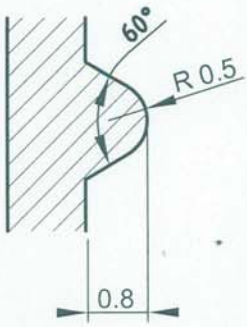
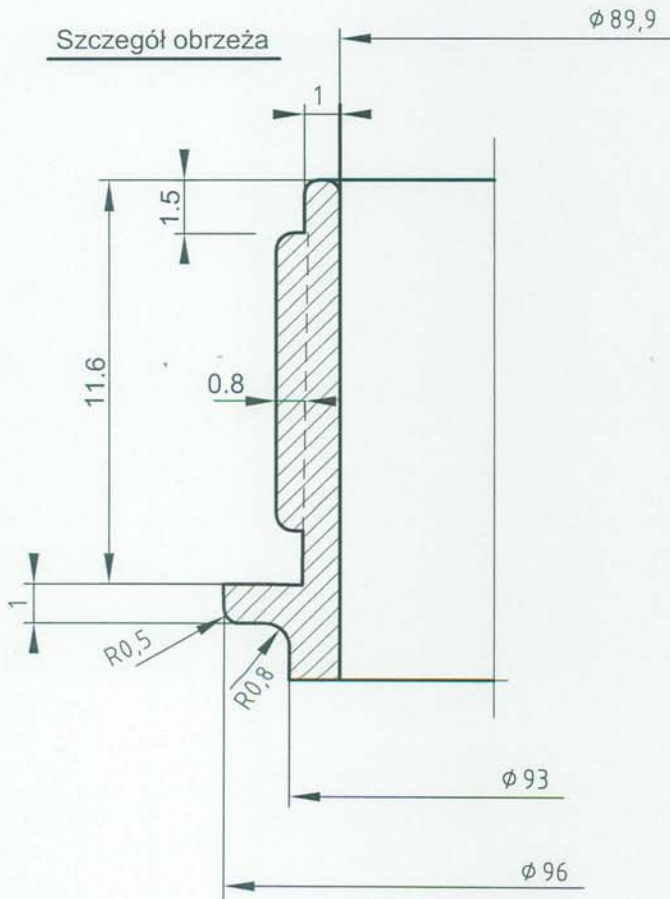

Szczegół dna

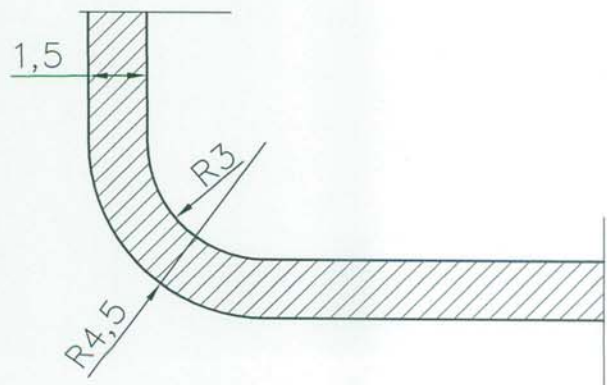

Dose H=36

FDO 200...PIP